

millboard

Live. Life. **Outside.**



Millboard Decking Installation and user guide



Contents

Tools & Equipment	3
Key points	4
Product Range & Usage	5
Storage & Handling	5
Colour	6
Pre-Install & framework	7
Cutting products	8
Fastening to the substructure	9
Gapping requirements	10
Keeping boards straight	11
Deck Edging & Fascia	12
Bullnose board	12
Flexible Edging	13
Taking Care	14
Frequently asked questions	15



Tools & Equipment

These are the tools/equipment that you need to install Millboard decking.



Mitre saw/jigsaw/handsaw

Millboard decking boards can be cut with standard wood cutting tools (i.e. mitre saw, jigsaw, handsaw). We would recommend using a carbon-tipped saw blade.



Personal Protective Equipment

When handling Millboard products, it is advised to wear long sleeves and gloves. When cutting products it is advised to wear a FFP3 dustmask, ear defenders and safety glasses. Knee pads are recommended to be worn when fitting decking.



Power drill and driver

Standard Power drill drivers can be used to install our Durafix® screws through the boards. Impact drivers should not be used when fitting Millboard decking.



Tool set

Standard carpentry tools will be needed to complete the installation, including: tape measure, a pencil, set square, planer, utility knife, surfboard and a drill bit set.

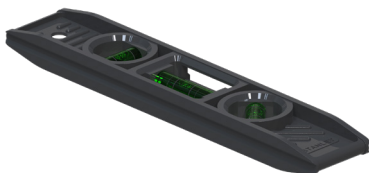

Spirit level

A spirit level is used to ensure that the subframe posts are set upright, as well as being used as a straight edge to ensure the joists/bearers are flush level with each other.



String line

A string line is used to ensure the boards are installed straight.

Other items that may be required (supplied by others):

Silicone spray (for use with the Durafix screws)

Polyurethane wood glue (for use when gluing mitre joints)

Superglue (for use when gluing mitre joints)

Packers (for use at the sides/end of boards, also to help the boards finish flush)





Key Points

1. **Planning** - If the installation of Millboard decking is taking place in conjunction with other building works, or as part of a bigger project, ensure that care is taken not to transfer substances, such as dirt and dust, on to the surface of the boards. The product should be covered or even installed after other construction works have taken place.
2. **Handling** - Be careful not to drag the boards off the pallet or over each other, as this could cause abrasion or marking on the surface.
3. **Pre-install** - Lay the boards out prior to installing, to achieve the desired mix of grain pattern and tonal variance *
4. **Working with the boards** - As Millboard decking is a hand-moulded product, slight variance in the board dimensions should be expected. This guide details best practise when working with the product.
5. **Framework** - The framework should be designed and built to complement the premium quality of the boards and built to last. The incorrect 'USE CLASS' grade of timber or poor subframe design and construction is likely to reduce the life or structural performance. Joist centre spacing is critical and is prescribed within this guide
6. **Fixings** - Our Durafix screws have been designed to be used with our Millboard decking. Other screws should not be used through the face of the boards. We provide very precise instructions in this guide regarding our Durafix screws, in order to achieve best possible finish for the decking. Please ensure that these instructions are followed accordingly.
7. **Board gapping** - We recommend 4mm gap between the side of boards and a 1mm gap at the end of the boards. Consistent board gapping should be adopted throughout the install. We recommend a 10mm gap between the boards/subframe and any abutting structure (wall, house doors)
8. **Edging profiles** - Our purpose-made edgings must be fitted to all steps and perimeters of the deck that will be subject to impact and regular foot traffic
9. **Taking care** - If the board surface becomes dirty during installation, this should be cleaned as soon as possible using warm soapy water and a brush. Within this guidance we provide advice regarding cleaning and upkeep. If you have any further queries please contact us accordingly
10. **Limited warranty** - Millboard shall be under no liability in respect of any defect arising from improper installation caused by failure to follow our instructions as set out in this guide.

For best results, please ensure that you have read and understood our guidance prior to starting your project.

*On delivery of our products, if you find the colour unacceptable or believe them to be defective in any way, please contact us.

Product Range & Usage

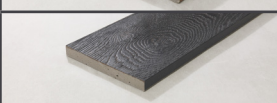
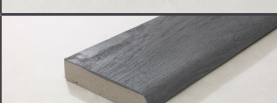
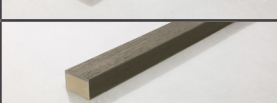
Range	Name	Size		Recommended use
Decking Boards	Enhanced Grain	126 x 32 x 3600		Square edged boards used for decking areas. boards can also be used as the fascia of a deck or as a picture frame as long as it is just for aesthetical purposes.* Important note: See page 13 ref fascia
		176 x 32 x 3600		
	Weathered Oak	200 x 32 x 3600		
	Lasta-Grip	200 x 32 x 3600		
Fascia	Fascia Board	146 x 16 x 3600		Fascia boards are used as a decorative cover for the subframe. they are used under the edging profiles.
Edging	Bullnose Board	150 x 32 x 3600		Rigid edging boards with one bullnosed edge.
	Flexible Bullnose Edging	50 x 32 x 2400		Flexible edging profiles used on the edges of decks and steps bending to a radius of 1.2m
	Flexible Square Edging	50 x 32 x 2400		
* Edging profiles must be used on edges that will sustain impact. square edged decking boards will exhibit more wear in these locations due to their profile				

Storage and handling

Millboard decking should always be stored on a flat surface or level bearers a maximum of 400mm apart and stacked face-to-face, not back-to-face.

Be careful not to drag the boards off the pallet or over each other, as this could cause abrasion or marking on the surface. Damage may not be visible immediately but the Lastane layer could be adversely affected with exposure to UV, this would not be covered under the terms of our limited warranty. Only move the pallet if the boards are safely strapped to it.

Wear gloves and long sleeves when handling the boards and take care when lifting them. We recommend that two people carry the boards.

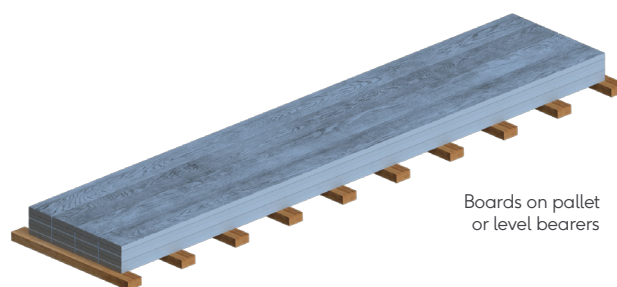

Boards on pallet or level bearers

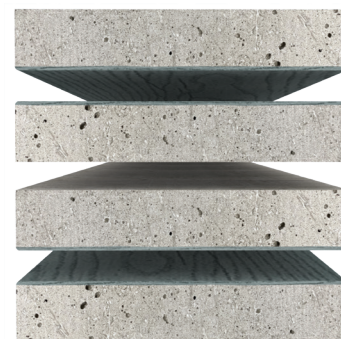

Boards stacked face-to-face

Colour

Millboard decking has been designed to replicate the natural variances of timber and is manufactured to have tonal variance in the colour.

We go to extraordinary lengths to recreate the look of natural products and therefore intentionally add secondary toning colours. This painstaking process means that there may be variance within the same board or between boards.

Buying all the Millboard decking you need at the same time should help to ensure that the colour is consistent and we would always recommend laying out the boards before installation, to create an effective, subtle blend. Antique Oak boasts more tonal variation per individual board than any of the other colours in the Millboard range.

As with all things constantly exposed to ultraviolet light and all weathers, natural weathering will occur slightly in time. This is normal for decking. On delivery if you find the colour unacceptable or believe them to be defective in any way, please contact us.



Colour tone may vary from batch to batch

It is best to lay boards out a day before installation, to ensure tone and grain variation is accounted for, and also to help the boards acclimatise to the project location. If there are any foreseen issues with the boards, this should be highlighted with Millboard before installing.

As with natural timber products, various grain patterns (i.e. Quarter sawn, plain sawn) will reflect the light differently so may appear a different shade to the eye. This is intentionally replicated with the Millboard products.



Different grains patterns

Pre-install & framework

Millboard decking is a hand-moulded product; slight variance in the board dimensions should be expected. Tolerances we deem as acceptable are: length +/- 5mm, width +/- 3mm, thickness +/- 2mm. (1)

Fitting boards flush: When working with the boards, packers may be required to shim up a board to create a flush finish between two boards.

Fitting to a string line: We recommend fitting deck boards to a string line. The boards may not be perfectly straight when they are delivered, but they can be pulled straight as they are being fitted by adjusting the gaps between the boards to be aligned with the string-line.

Board ends: Please bear in mind that as the ends of the boards may need to be trimmed to make them square, this will reduce the length of the boards which could then affect the required joist spacing.

Decking falls: We recommend that decking is built to a minimum slight fall of 1:200 away from any buildings. This is not a regulation requirement but does help to negate pooling which in turn helps to reduce dirt retention, algae build up and maintenance.

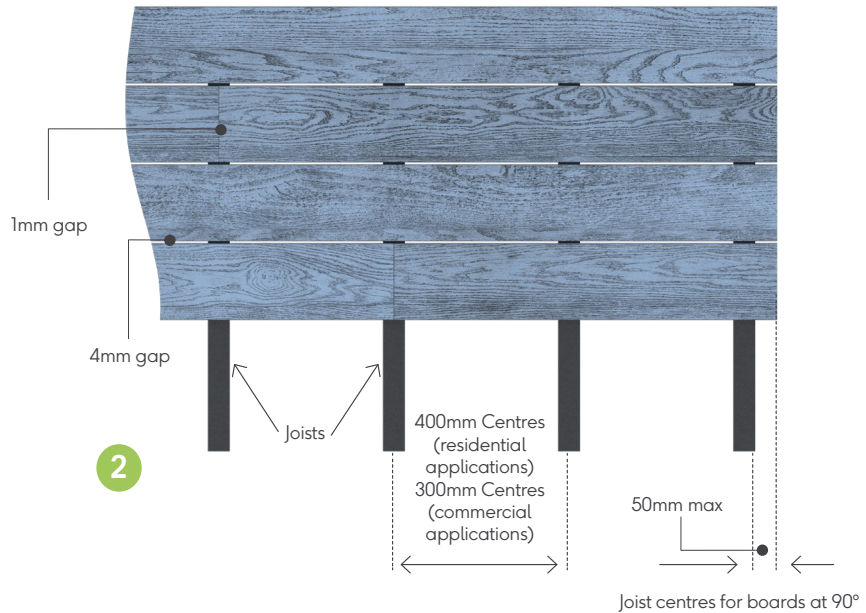
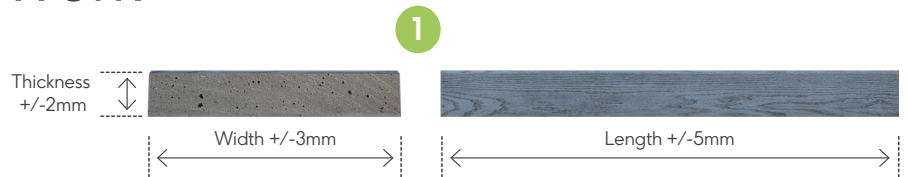

Joist spacing: For boards at 90° joist spacing of 400mm centres max should be used for normal residential use. On commercial use, bridges, balconies, moorings, doorways and steps, 300mm centres max should be used. (2)

For laying boards 45° to the joist, reduce the joist centres to 300mm for residential and 240mm for commercial use, (3) Alternatively turn the joists round to be at 90° to the board direction (4) as this is less wasteful of material and time. If you need to cut Millboard decking down along the length, reduce the joist centres accordingly. A minimum of three joists is required for any cut boards. (5)

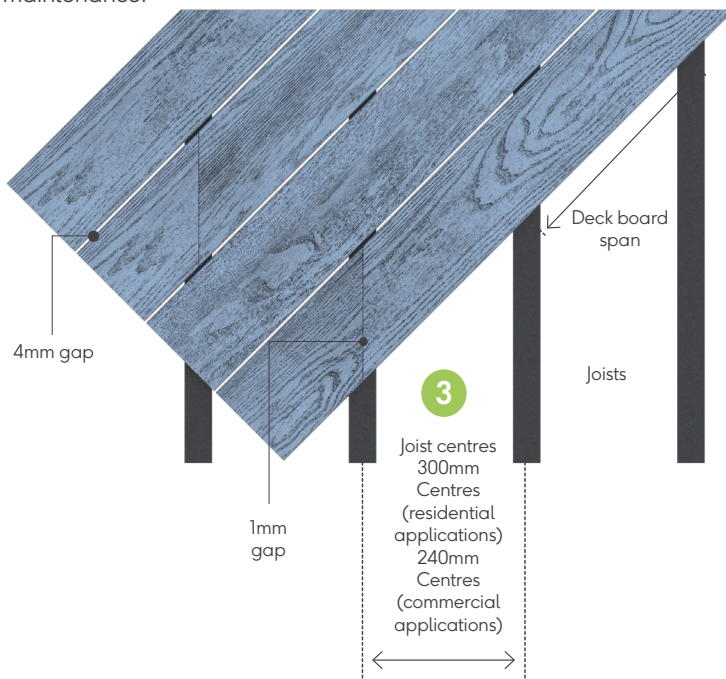

Joist centres for boards at 45°

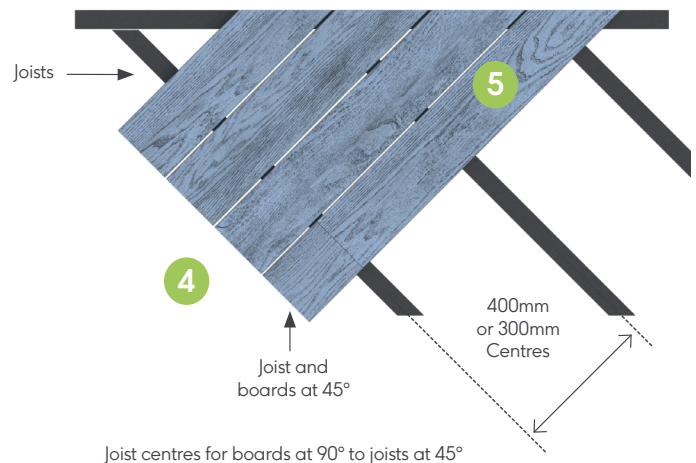

Joist centres for boards at 90° to joists at 45°

Subframes

The subframe of a decking area is one of the most important parts of having a deck installed. Whilst the subframe is generally hidden, it is crucial for the deck's longevity. Millboard decking can be installed on Plas-Pro (recycled plastic), DuoSpan (aluminium) or treated timber subframes. If timber is to be used as the subframe then relevant guidance from industry professionals should be followed (Trada, The WPA, etc). This includes, but is not limited to: the whole subframe should be timbers treated to use Class 4, applying end grain preservative to all cuts and using Stainless Steel or HDG screws and bolts for fixing it together. High quality deck tape should also be applied to the top of the joists before deck board installation.

More information on subframe choices can be found in our in-depth subframe guide www.millboard.com/en-gb/subframes

For more in-depth installation details on the DuoSpan or Plas-Pro please refer to our PDF installation guides and 'How to' videos on: www.millboard.com/en-gb/installation-guides

Cutting products

Millboard products can be cut with standard wood cutting tools and machinery (i.e. mitre saw, jigsaw, handsaw). We recommend a carbon-tipped (TCT) saw blade. It also mills very cleanly with a router and can be bored or drilled with ease.

It's advisable to connect a dust extraction vacuum to any machine or power cutting tools and to wear an FFP3 dust mask, safety glasses, gloves and long sleeves when working with Millboard.

Make sure that the boards are adequately supported when cutting. Boards can be cut face-up or face-down

We recommend that all ends are squared off with a slight back cut of around 2-3 degrees before they're installed.

Reduced dust cutting: For situations where the creation of dust needs to be kept to a minimum then Millboard can be cut with a hand saw or by using a wet cutting saw such as the Makita DCC5007.18v 125mm dustless Disc cutter with Makita water supply cover and the B- 57722. 125mm Tungsten Carbide Grit Blade fitted to a saw rail.

Disposal of Millboard material: Dispose of board off-cuts by disposing as general waste or sending to a municipal incinerator for energy replenishment. Don't burn them at home.



Mitre saw with extraction

Tip:

If there is a breeze/wind when cutting the boards, locate the saw up wind so that excess dust is blown away from the operator & project. Suitable dust extraction/vacuums fitted to saws will help reduce excessive dust.

Fastening to the substructure

Methods of fixing Millboard decking

Use Durafix screws to fasten Millboard decking. They can be driven through the face of the boards or through the side using the DuoFix side-fixing guide. (6),

DuoFix Side fixing guide: When using the DuoFix guide, this creates a 6mm gap between boards. DuoFix should be used in accordance with the instructions on the DuoFix box. These can also be found on - www.millboard.com/en-gb/installation-guides

Using Durafix deck and fascia screws

The screws should be given a liberal coating of spray silicone lubricant before use (7). When driving the screws in, push firmly down on the screw as it is driven in. Don't let the screw spin on the surface. (8)

At the same time apply pressure to hold the deck board down onto the subframe, to stop it riding up the screw (8a). Drive the screw head 8mm below the surface of the board. This should leave a minimal witness mark (9).

When installing the boards through the face with the Durafix fixings, there is no need to pre-drill or countersink, just drive the screw straight in. Use a standard drill driver with the TX15 bit provided and not an impact driver to fix the Durafix screws to the decking as this can damage the Lastane surface leaving a larger mark where the screw has entered, It can also break the drive bit and screw head, as well as impede the board from being fastened directly against the subframe.

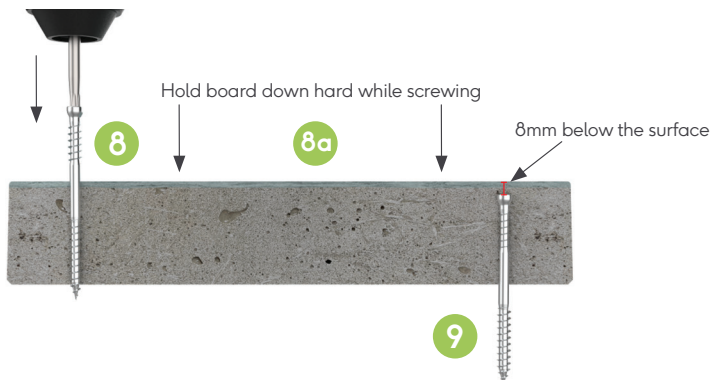

Millboard decking can be installed on to a timber frame using the Durafix 4.5x60mm screws, (10)

When fixing into Plas-Pro (11) or DuoSpan (12) the Durafix 4.5x45mm screws should be used.

When installing the fascia boards to Plas-Pro or timber, that are less than 30mm thick, Durafix 4.5x35mm screws should be used.

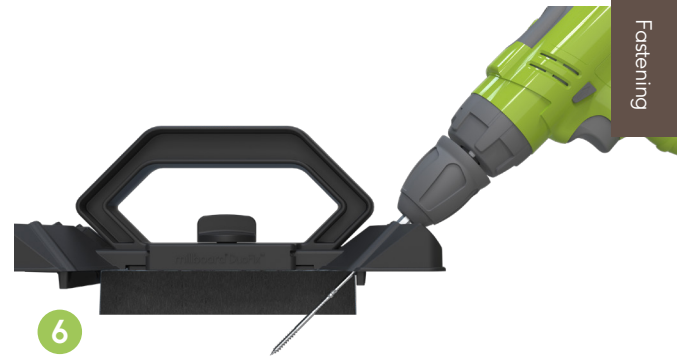

DuoFix side-fixing Guide

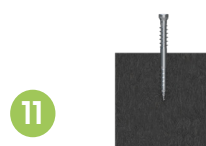
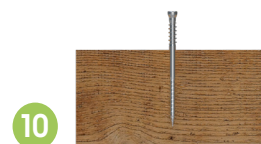

Failure to use our Durafix screws with the bit provided or not fitting according to these guidelines may invalidate the warranty and affect the overall look of the deck. Two screws per board should be used where the board crosses a joist. Use three at the ends of the boards. (13)

The screws at the ends of the boards should be fixed at a slight angle to prevent being too close to the end of the board (14), positioning the screws 20-25mm from the ends and 20mm minimum from the sides of the boards. Board ends should be supported by a minimum of 20mm (15).

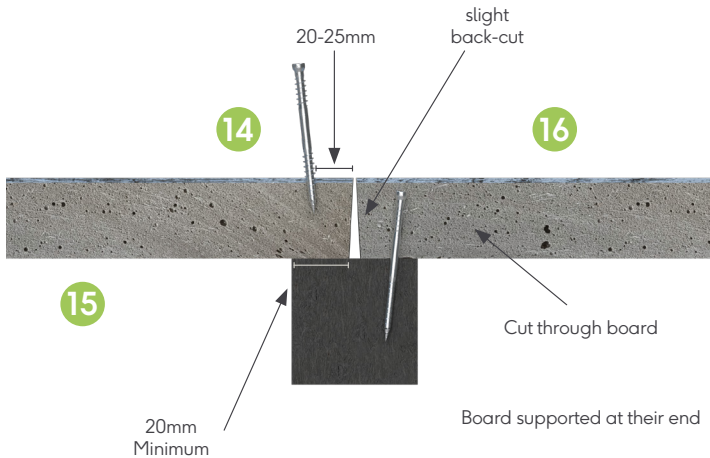

Cuts must always be positioned over the joist. We recommend that all ends are squared off with a slight back cut of around 2-3 degrees before they're installed (16).

This back-cut makes it easier to adjust butt joints if required, by carefully running a handsaw along the gap to make the butt joint square and evenly gapped.

Gapping deck boards

We recommend a 4mm gap between the sides of boards and 1mm gap at the ends on butt joints. The sides of the boards are not always square but have a varied taper, therefore the gap on the side of the board should be set 10mm down from the top of the board to help keep the gaps consistent and the boards running straight. The Multi-spacer (FP36P010) has been specifically designed to work with the boards and provides gap spacing of 3-6mm. (17).

When fitting deck boards using the DuoFix Side Fixing Guide, this creates a 6mm gap between boards.

A gap between the boards smaller than 4mm can lead to dirt build-up and can prevent drainage between the boards. It can also lead to the boards rubbing against each other causing a squeaking noise. Gaps bigger than 6/7mm can result in items falling through or getting stuck, such as high heels, children's fingers, rings, keys, etc, as well as exposing more of the joist which is often not the desired look

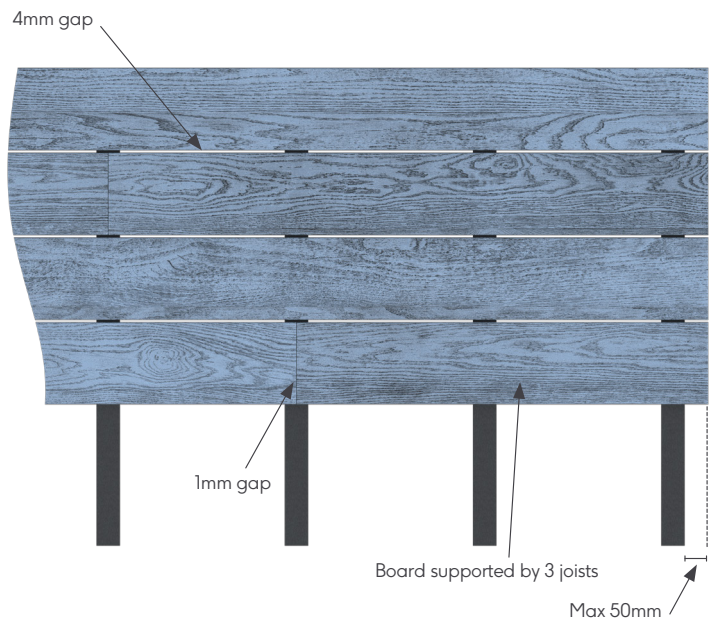
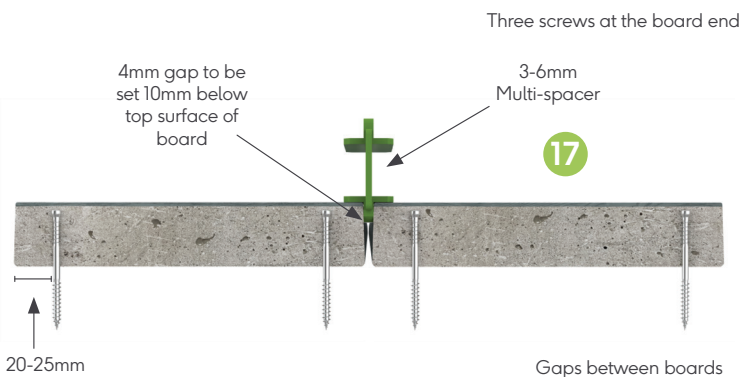
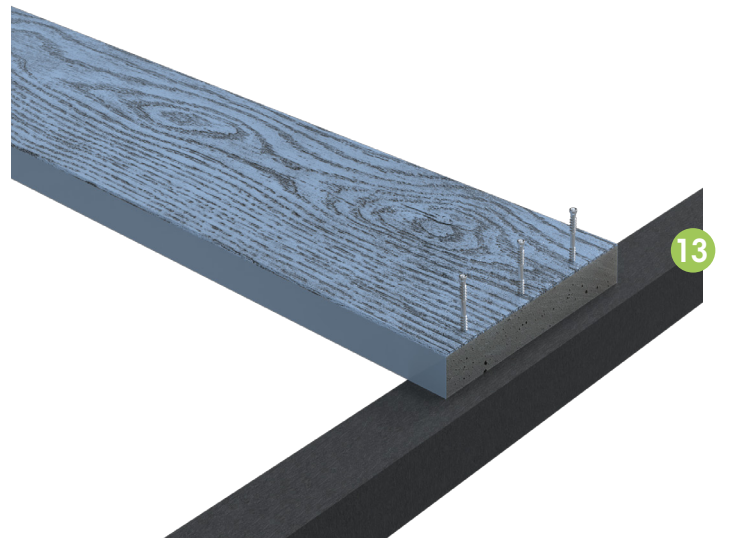

General gapping on boards

A 10mm gap should be left between the deck boards and any solid surface (house wall, door sill, post, garden wall, glass balustrade, etc) to facilitate drainage and allow for any movement. (18)

Whatever gap is used between the deck boards, we recommend maintaining the same gap between the deck boards and any edgings, picture frame or breaker boards, for aesthetic consistency. (19)

The flexible edgings should always be butted up tight to the deck boards for maximum support. (see page: 13)

Keep boards straight

Always start installing the first row of deck boards to a string line. Fasten the boards at one end then work along the board fixing as you go, adjusting spacing or to the string line as necessary. We recommend checking the boards against a string line every 5th row, As there may be slight variation in width and thickness, packers can be used, or one board can be planed (by a maximum of 2mm), to create a flat finish between two boards. (21)

Tip:

It is best practice to not screw the end of the deck board down until the next board has been offered up to it to check for alignment.

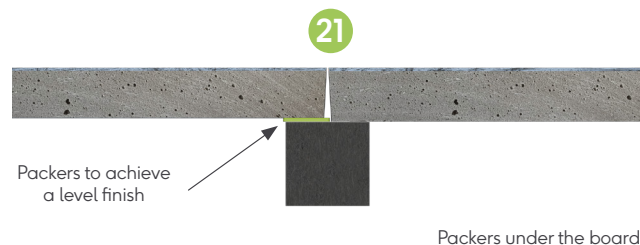

Tip:

When installing decking over large areas with straight runs, it is sometimes easiest to carefully measure and install every 5th row of boards to a string-line. Then, infill between these with 4 rows of boards, using the multi-spacers, ensure consistent gapping before installing all 4 rows at once.



Gap between boards and solid surfaces

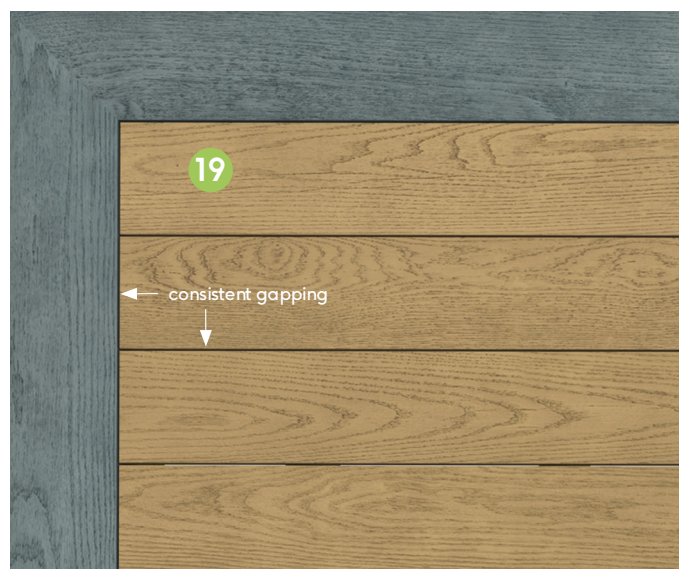

Gap around the edge

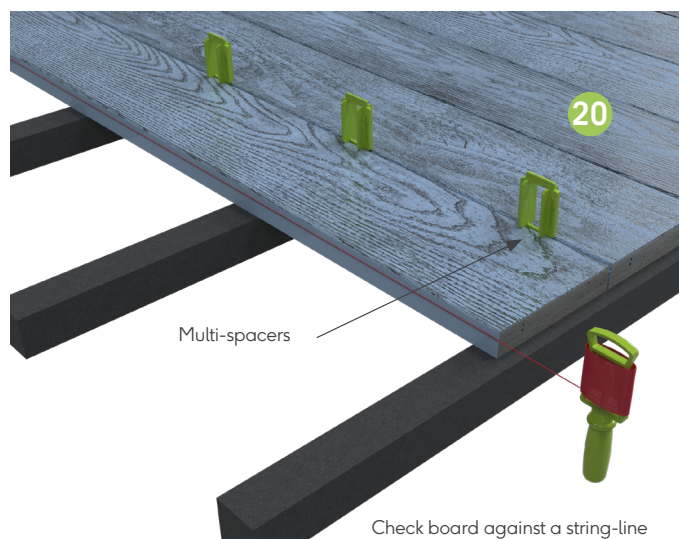

Deck Edging & Fascia

We recommend that our purpose-made edgings are fitted to all steps and perimeters of the deck rather than using a standard deck board. Where the deck edge is likely to sustain impact or wear, such as a step, a standard square edge deck board should not be used.

Any visible cuts need to be coated with Millboard Touch-up Coating. This coating should not be used on the surface of the boards. The edging profiles should sit over the top of any fascia boards used to cover the subframe. (23)

When mitring the edging or fascia profiles for a corner, it is best practice where possible to cut the mitre from the same board to account for natural variance in grain and sizing. (22)

Gluing mitres

All mitred corners must be glued together. We recommend using a thin bead of gel PU wood glue on the core material and a continuous bead of super glue for the Lastane.

Fascia boards

Fascia boards are used under the decking or edging profiles to cover the sides of the subframe, they will bend to a radius of 1.2m (at 20°C) and need to be fixed with two Durafix 4.5x35mm screws at 300mm centres.

Joining fascia boards

When two fascia boards meet along the deck, these should be jointed together on a 22.5° angle back cut so that one piece slides under the other. The upward facing cut should be painted with touch-up coating prior to being installed and should not be glued. If a fascia joint finishes on a curve, the boards should be joined on a 45° angle and glued together prior to being fitted in place. Take care to support the glued joint while bending it.

Bullnose Board Edging

The Bullnose Board is a 150mm wide edging with a bullnosed front edge. It is a rigid product used for straight runs on edges of decks, steps and seating. The maximum overhang of the Bullnose board is 40mm from the front of the fascia. Both the standard deck boards (32mm) and the thinner fascia board (16mm) can be used as a fascia under this product. The maximum size of cut-out for LED lighting under this board should be 17x9mm and should be a minimum of 11mm from the front of the board edge. (23).

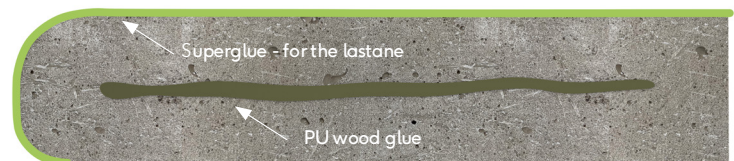
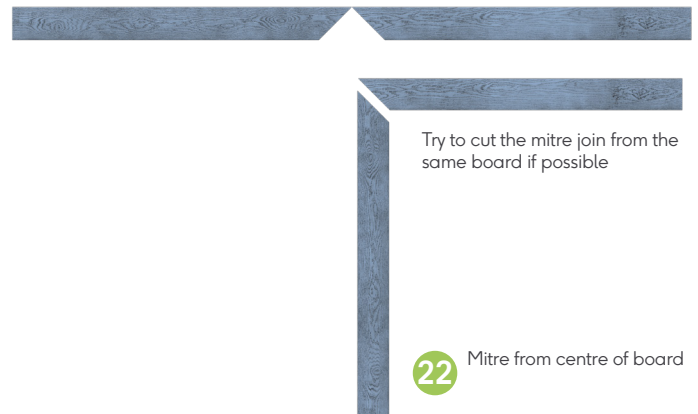

Location of glue on mitres

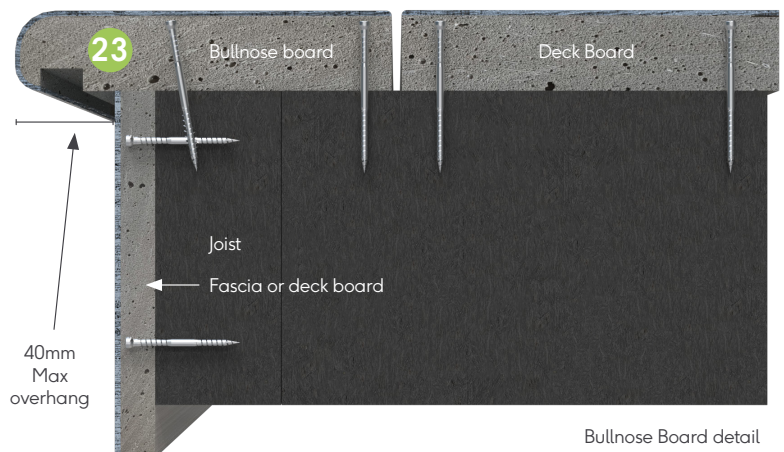

Bullnose Board detail

Bullnose Board butt joints

These boards would normally be fully supported along their entire length but can span up to 400mm centres and should be installed with two Durafix screws every 300mm. When two Bullnose Boards come together along the deck, these should be joined together on a 22.5° scarf joint so that one piece slides over the other. The upward facing cut should be painted with touch-up coating prior to being installed and should not be glued. (24)

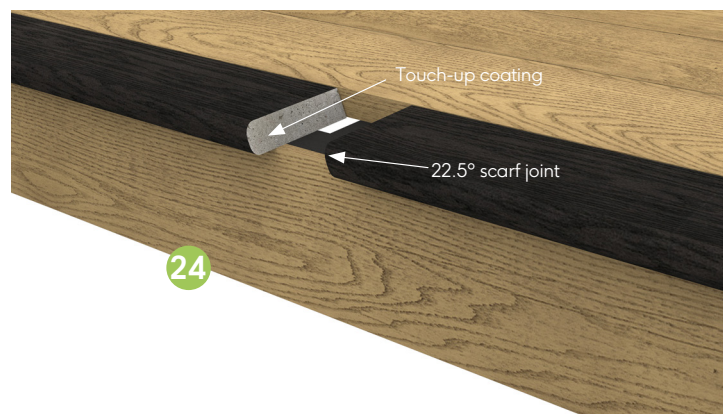

Bullnose Board or Fascia Joint

Flexible Edgings

The Flexible edgings are a 50mm wide profile with either a bullnose round or square edge. Use these profiles to add curved details to deck edges, steps and seating edges.

They bend to a 1.2m radius (at 20°C) and need to be fully supported by a joist minimum of 25mm along its entire length, with a maximum overhang of 9mm from the front of the fascia. (25).

Top Tip:

Fix the fascia board slightly higher than the joist and plane down to the joist to create a full flat seat for the edging to sit on.

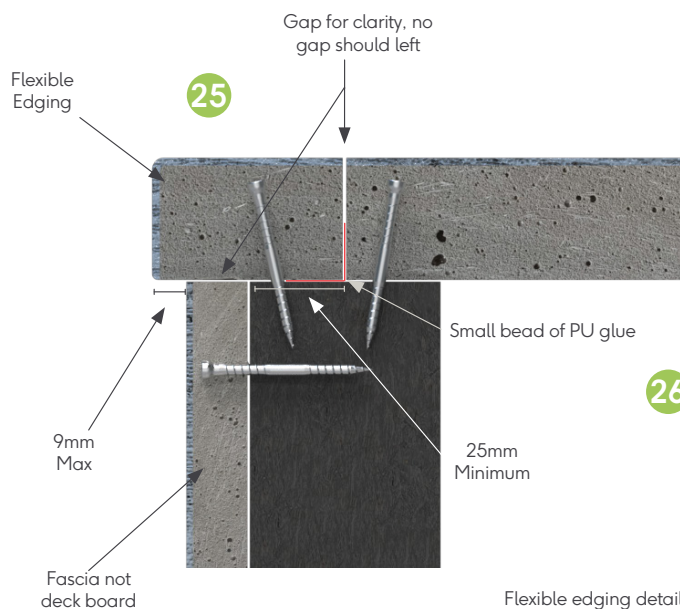

Flexible edging details

When installing the flexible edging, start from the end with a double screw point and work along, screwing at 150-200mm intervals as you go. Some screw holes may be partially visible on the flexible edgings.

Top Tip:

Make sure you use plenty of silicone spray on the screws and keep the downward pressure on the screws for as long as you are driving it in, until the screw head has gone at least 10mm below the surface.

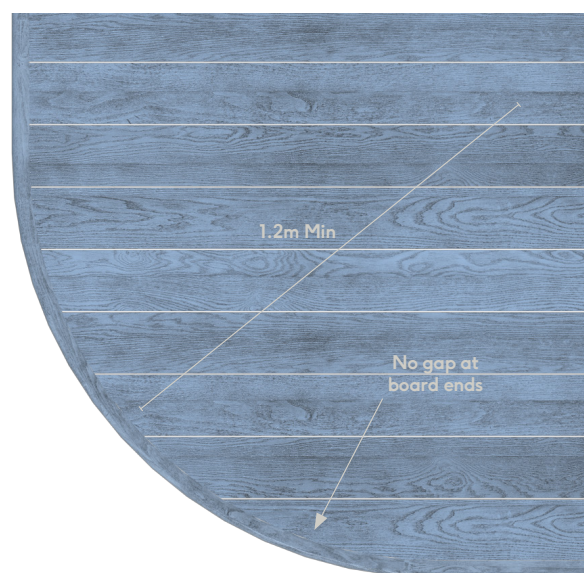

Edging used around a radius

The flexible edging should sit tight up against to the deck boards, this will give it maximum support. Apply a small bead of PU glue at the back before fixing the flexible edging in place. (26).

Flexible Edging Joints

If possible, try to make sure that the joints on flexible edging don't start or finish on a curve. If the radius of the curve is bigger than a full length of edging then pre-glue enough lengths together to run around the curve in one piece. (27).

When joining two lengths of 50mm edging around a curve, it is best to join them on a 45° angle so one fits behind the other. Glue this joint with superglue and hold together for 10-15 seconds. Then continue to screw the flexible edging around the curve.

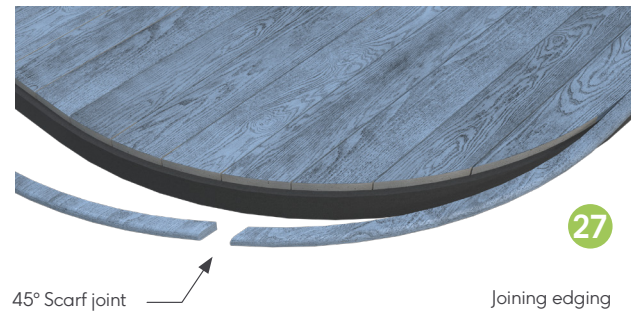

Taking care

If the board surface becomes dirty during installation, this should be cleaned as soon as possible using warm soapy water (dishwashing liquid) and a brush.

Clean your decking when required to remove leaves and general dirt particles.

Cover the boards from any surrounding building works especially if there are silicone renders being applied. If possible try to complete all rendering at least 2 weeks before decking installation as migration off the walls from rain can still wash down dust onto the deck and stick to the surface release agent on the new boards. Overspray from painting can also mark the surface of the boards. Stubborn marks may be removed with a range of different cleaners depending on the mark. Please contact us for more information on [02476 439 943](tel:02476439943).



Pressure washers can be used carefully on Millboard decking for cleaning and rinsing. We recommend:

- A PSI no greater than 2,000 should be used, with a 40 to 60 degree spread fan tip
- The head should always be kept around 300mm away from the surface
- Please note that using pressure washers may increase the chance of screw holes becoming more visible
- Direct, prolonged and intense contact could damage the surface of the boards

Frequently asked questions

Where can I use Millboard decking?

Millboard decking is extremely versatile and can be used in practically every outdoor space (subject to building control).

Create decks, cladding, balconies, roof gardens, boardwalks, bridges, pontoons, seating, steps, planters and more.

Millboard decking can be used as the decorative face for most outdoor designs, as long as it is fixed to a structural element.

Does it expand or contract?

As Millboard is made from a resin mineral composite it is stable in comparison to timber or composites based on wood. The amount of movement that is acceptable is up to 0.2%. We recommend a 4mm gap between the sides of boards and a 1mm gap between the ends of boards, a 10mm gap should be left between the boards and any solid surface to aid drainage.

Why do my boards have water puddling on the surface?

Surface water will always be more prevalent on Millboard decking due to it being made from a non-porous composition. Laying the boards to a slight fall away from a building will help to drain the water off the surface, though it will not drain all of the water off the boards. Adhere to relevant gapping in this guide to assist drainage, the boards have a cupping tolerance of 2mm. Surface water can be taken off the surface of the boards with a brush or large squeegee. Frost or ice can be removed by spreading white salt across the board surface.

My boards have just been laid and have a slight oily/shiny finish?

As the boards are a moulded product we use a release agent in the manufacturing process so when the boards are first delivered this release agent is still on the surface. This may result in the boards looking like they have a shiny or waxed surface or have small particles of dirt and water puddling. This release agent will come off the surface within 6-8 weeks due to natural weathering.

This process can be accelerated by

cleaning the boards with warm soapy water and a stiff brush after installation.

Can you use it for load bearing applications (i.e. structural)?

Millboard decking should not be used in structural applications. Millboard decking would need to be fixed to a structural frame, either made from DuoSpan, Plas-Pro or timber.

Does Millboard decking get hot in the sun?

As with all composite products, the surface of the boards tends to be hotter than timber when exposed to direct sunlight.

Darker colours particularly will feel hotter and may be uncomfortable to walk on in bare feet. Under direct sunlight and high temperature, footwear may be necessary. Special caution should be taken when using decking in areas near heat/UV reflective glass, or around pools.

What tolerances should be allowed?

There will always be a slight variance in the board's dimensions due to the fact that we mould from natural oak, and due to the pressure of the moulding process. Despite this, we calibrate the boards to maintain as consistent a profile as possible.

The manufacturing tolerances are: Width: ± 3 mm. Length: ± 5 mm. Thickness: ± 2 mm.

The dimensions of the Weathered Oak style may vary more between moulds due to the fact that they are moulded from timeworn oak with minimal changes to the dimensions.

When working with the boards, packers may be required to create a flush finish between two boards.

What fixings should be used to fix Millboard decking?

Following extensive trials, we supply Durafix stainless steel screws, designed specifically for Millboard decking - this is a requirement of our limited warranty.

There's no need to pre-drill or countersink Millboard decking, the unique Lastane material coating flexes back over the screw-heads, leaving a minimal witness mark. This may be more visible on the lighter colours.

Can I use a standard board as an edging piece?

Yes you can, only where the edge is merely aesthetic, such as a balcony edge, if this is your preferred finishing option.

However, where the edge is likely to sustain impact, such as a step, square edge deck boards should not be used. Our edging boards have been specifically designed to withstand the knocks and scrapes associated with step edges and other associated applications. In high footfall areas or areas needing contrasting edges, it may be necessary to add metal edging to the edges of the area.

Will heat sources affect my decking boards?

Where heat sources are in prolonged proximity to the boards, the board surface may become affected. Keep any heat source 1m away from the board surface. Non-combustible materials should be used in these areas. In instances where there is burning wood or coal, they will need to sit the fire bowl/brazier onto a porcelain or cement tile/slab. The slabbed area needs to extend about 1m outside the fire bowl/brazier. Any embers or burning material needs to be removed immediately to prevent any damage or lasting marks to the Millboard surface. Patio heaters or infra red heaters are not known to affect the boards.

Does Millboard decking come with a warranty?

Yes Millboard provide a UK-backed Residential 25 year Limited Warranty or a Commercial 10/12 year Limited Warranty on decking products, to provide customers with peace of mind. Register your warranty at www.millboard.com/en-gb/limited-structural-warranty-registration

Something else?

For any other technical, installation or care questions:

- Visit www.millboard.com
- Call our Technical Team on 024 7643 9943
- Email us at technical@millboard.co.uk

Live. Life. Outside.



The Millboard Company Ltd
UK Head Office
1 Argosy Court,
Scimitar Way,
Coventry
CV3 4GA

T: +44 (0) 24 7643 9943
E: enquiries@millboard.co.uk

millboard.com



Company registered No. 06061318
VAT No: 980 616602

© 2025 The Millboard Company Ltd., Millboard®, Lastane®, Durafix®, Lasta-Grip®, DuoSpan®, DuoLift®, Envello® and the phrase "Live. Life. Outside.™" are protected trademarks. Patents and Patents Pending apply to Millboard® products. The company will vigorously defend its patent rights. Due to printing restraints, actual colours may vary from those shown in brochure. This brochure is not to be reproduced or copied without written permission from Millboard directors. Millboard has a policy of continual improvement to specification. Product blend, colours and sizes may change without notice. All sizes and measurements are nominal. Information is correct at time of going to press. Patent numbers include GB 2445714, GB 2449184, USA 8,065,849, CAN 2664329, EU 1951971.

2025v1